

version .0

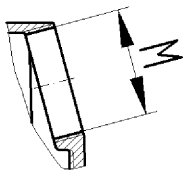

version .1

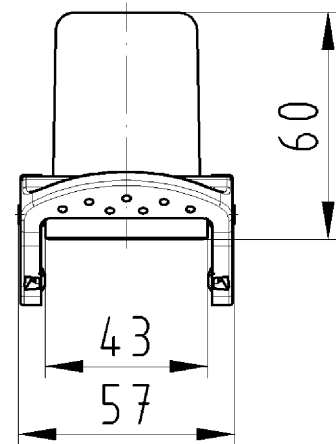
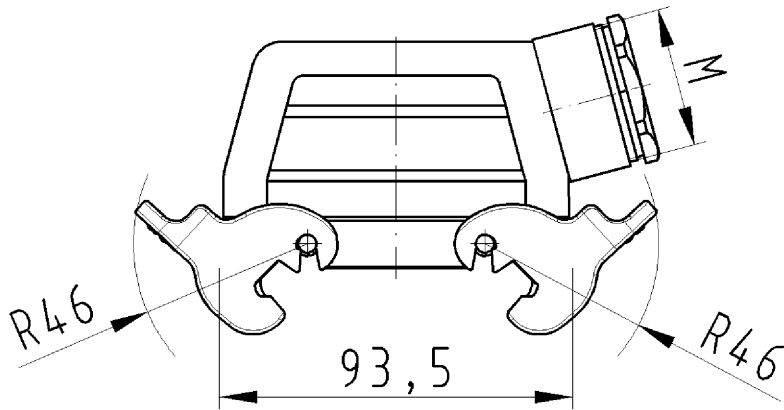
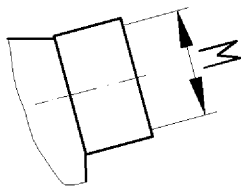

version .2

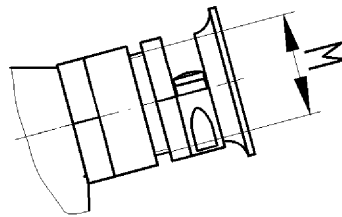

version .3

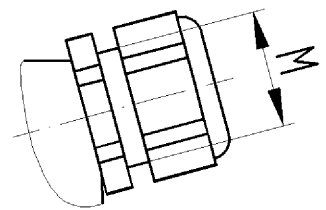

version .5

IP 65

Gehäuseoberteil
70.355.1635.0

Zeichnungsnummer
70.355.1635.010W
Gehäuseoberteil

22.11.2007
Roppelt Dominik
M 1:2